

DS-D5A86RB/A

## Interactive Tablet

The Interactive tablet (hereafter referred to as the “device”) integrates functions of computers, projectors, interactive whiteboards, sound boxes, cameras (optional), HDTVs, advertising machines and so on. The device integrates technologies like 4K display, infrared touch, human-machine interaction, multi-media information processing, and network transmission and provides users with various features such as writing, annotating, multi-screen sharing, and remote video call (optional).

The Interactive tablet is mainly used for remote video conferences, trainings and guidance, medical consulting, and other events in kinds of offices, meeting rooms, multi-media classrooms, exhibition halls and so on.



## Key Features

- 4K display, and the resolution of the input signal is up to 3840 × 2160.
- 20px ultra fine writing, and 1 mm writing in diameter recognizable.
- Built-in Wi-Fi realizes wireless screen mirroring without any cable connection.
- Built-in interactive whiteboard system allows annotating and sharing by scanning QR code.
- Display looping out.
- Various audio and video interfaces for device access.
- Built-in network switch chip saves a network switch.
- Built-in Android system supports kinds of applications.
- Compatible with OPS/OPS-C devices, and built-in systems can seamlessly switch between each other.
- Ultrathin aluminum profile frame design.



## Specifications

Model		DS-D5A86RB/A
Screen	Diagonal Screen Size	86"
	Backlight	LED Backlight
	Resolution	3840 × 2160 @60 Hz
	Display Scale	16:9
	Pixel Pitch	0.4935(H) × 0.4935(V) mm
	Color	10 bit
	Brightness	350 cd/m <sup>2</sup>
	Contrast	1200: 1
	Response Time	8 ms
	Viewing Angle	Horizontal 178°, vertical 178°
Interface	HDMI IN	2, Max. 4K@30Hz
	HDMI Out	1, Max. 4K@60Hz
	VGA In	1, Max. 1080P@60Hz
	Audio In	2
	Audio Out	2
	USB Interface	2 USB on front panel , 2 USB on side panel
	RJ45 (100Mbps ports)	2
General	Power Supply	100 V to 240 VAC, 50/60 Hz
	Power Consumption	< 600 W
	Net Weight	77.760 kg
	Gross Weight (with package)	100.760 kg
	Product Dimensions (Width × Height × Thickness)	1990 × 1186 × 118 mm
	Package Dimensions (Width × Height × Thickness )	2205 × 1413 × 315 mm
	Working Temperature	0°C to 40°C
	Working Humidity	10% to 90%
	Built-in System	CPU
Memory		2 GB

	<b>Storage</b>	32 GB
	<b>NIC</b>	Built-in 100Mbps NIC, supporting routing
	<b>Speaker</b>	Built-in 16 W speaker × 2
	<b>Decoding</b>	H.265/H.264, 4K@60 × 1
	<b>Operation System</b>	Android 5.0

## Available Models

DS-D5A86RB/A

## Physical Interface

Bottom interfaces of the rear panel:

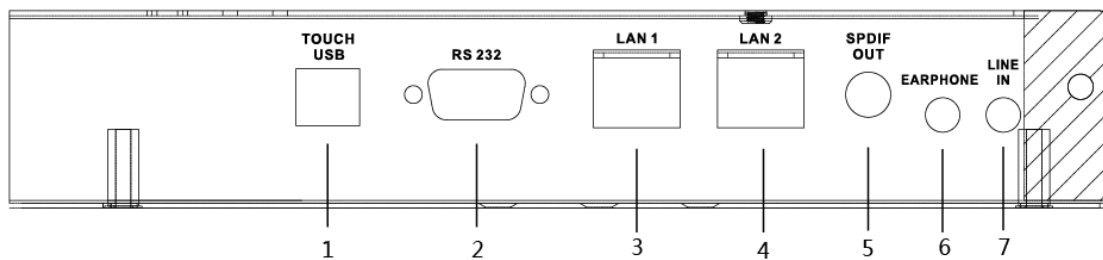

Interface	Description	Interface	Description
1.TOUCH-USB	Peripheral Touch Interface	2.RS-232	RS-232 Serial Port
3.LAN 1	Ethernet Interface 1	4. LAN 2	Ethernet Interface 2
5.SPDIF OUT	Digital Multi-media Speaker Interface	6.EARPHONE	Earphone Interface
7.LINE IN	Audio Input Interface	---	---

Left interfaces of the rear panel:

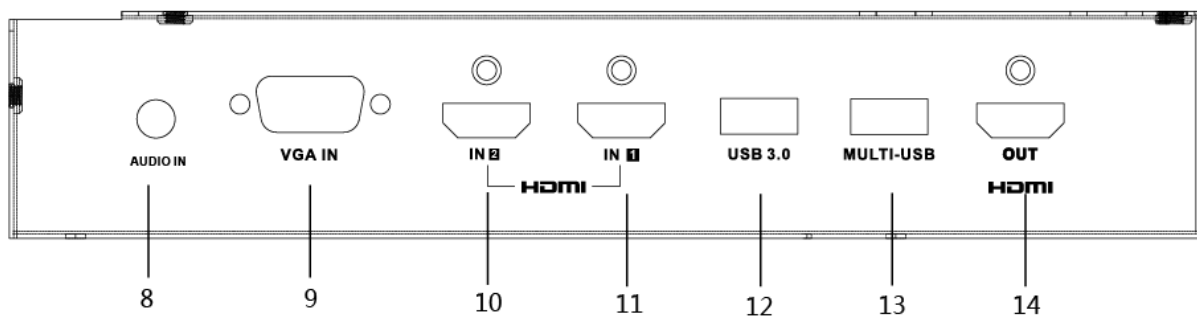

Interface	Description	Interface	Description
8.AUDIO IN	Audio Input Interface	9.VGA IN	VGA Input Interface
10.HDMI IN2	HDMI2 Input Interface	11.HDMI IN1	HDMI1 Input Interface
12.USB 3.0	USB 3.0 Interface	13.MULTI-USB	Multi-function USB Interface
14.HDMI OUT	HDMI Output Interface	---	---

**Dimensions (unit: mm)**

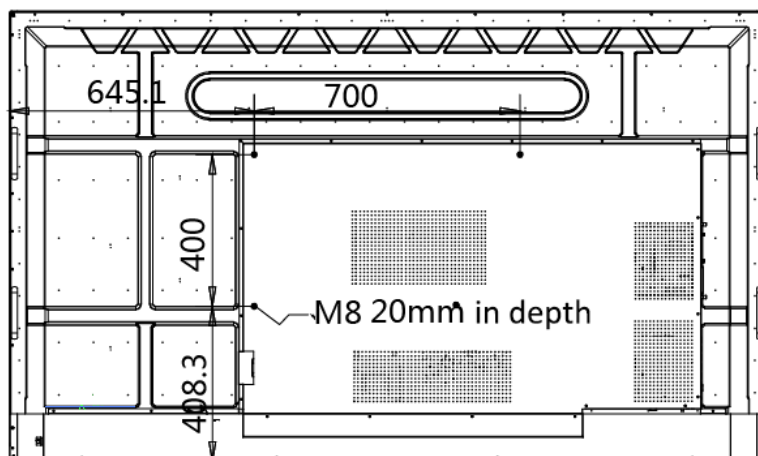
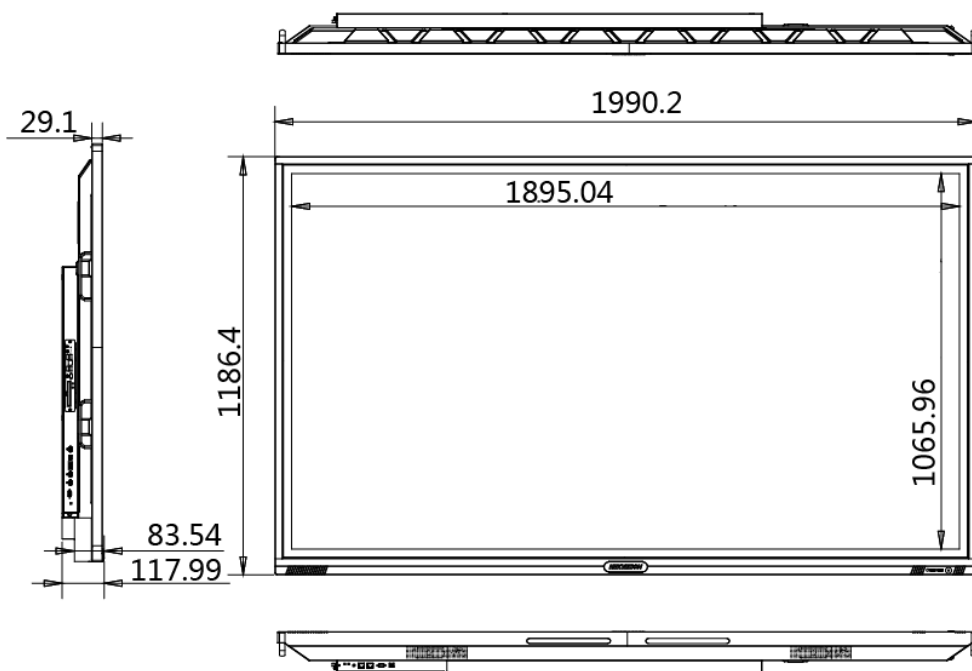

## Mounting Method

Wall mounting

The rear should be installed on the hook holes

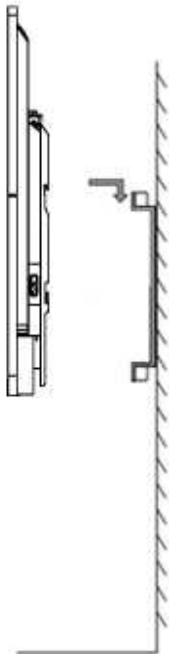
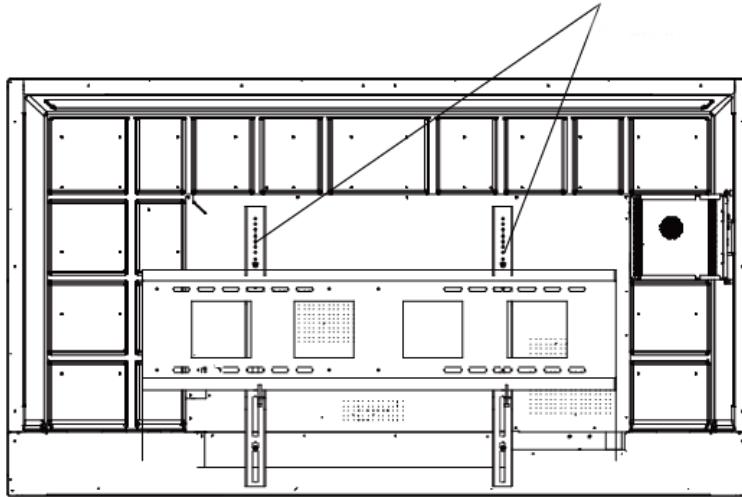

**i** NOTE

The bracket for wall mount can be moved horizontally. Please leave a space no less than 6 cm at each side, or a space no less than 12 cm at one side for maintenance service.

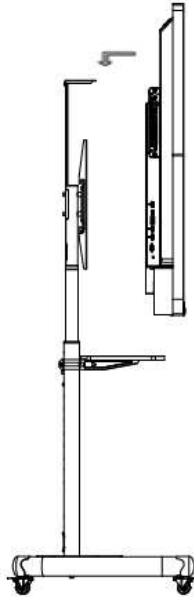
**Mobile Mounting**

Distributed by

**HIKVISION®****Headquarters**

No.555 Qianmo Road, Binjiang District,  
Hangzhou 310051, China  
T +86-571-8807-5998  
overseasbusiness@hikvision.com

**Hikvision USA**  
T +1-909-895-0400  
sales.usa@hikvision.com

**Hikvision Australia**  
T +61-2-8599-4233  
salesau@hikvision.com

**Hikvision India**  
T +91-22-28469900  
sales@pramahikvision.com

**Hikvision Canada**  
T +1-866-200-6690  
sales.canada@hikvision.com

**Hikvision Thailand**  
T +662-275-9949  
sales.thailand@hikvision.com

**Hikvision Europe**  
T +31-23-5542770  
sales.eu@hikvision.com

**Hikvision Italy**  
T +39-0438-6902  
info.it@hikvision.com

**Hikvision Brazil**  
T +55 11 3318-0050  
Latam.support@hikvision.com

**Hikvision Turkey**  
T +90 (216)521 7070- 7074  
sales.tr@hikvision.com

**Hikvision Malaysia**  
T +601-7652-2413  
sales.my@hikvision.com

**Hikvision UK & Ireland**  
T +01628-902140  
sales.uk@hikvision.com

**Hikvision South Africa**  
Tel: +27 (10) 0351172  
sale.africa@hikvision.com

**Hikvision France**  
T +33(0)1-85-330-450  
info.fr@hikvision.com

**Hikvision Kazakhstan**  
T +7-727-9730667  
nikia.panfilov@hikvision.ru

**Hikvision Vietnam**  
T +84-974270888  
sales.vt@hikvision.com

**Hikvision UAE**  
T +971-4-4432090  
salesme@hikvision.com

**Hikvision Singapore**  
T +65-6684-4718  
sg@hikvision.com

**Hikvision Spain**  
T +34-91-737-16-55  
info.es@hikvision.com

**Hikvision Tashkent**  
T +99-87-1238-9438  
uzb@hikvision.ru

**Hikvision Hong Kong**  
T +852-2151-1761  
info.hk@hikvision.com

**Hikvision Russia**  
T +7-495-669-67-99  
saleru@hikvision.com

**Hikvision Korea**  
T +82-(0)31-731-8817  
sales.korea@hikvision.com

**Hikvision Poland**  
T +48-22-460-01-50  
info.pl@hikvision.com

**Hikvision Indonesia**  
T +62-21-2933759  
Sales.Indonesia@hikvision.com

**Hikvision Colombia**  
sales.colombia@hikvision.com

DS-D5A75RB/A

## Interactive Tablet

The Interactive tablet (hereafter referred to as the “device”) integrates functions of computers, projectors, interactive whiteboards, sound boxes, cameras (optional), HDTVs, advertising machines and so on. The device integrates technologies like 4K display, infrared touch, human-machine interaction, multi-media information processing, and network transmission and provides users with various features such as writing, annotating, multi-screen sharing, and remote video call (optional).

The Interactive tablet is mainly used for remote video conferences, trainings and guidance, medical consulting, and other events in kinds of offices, meeting rooms, multi-media classrooms, exhibition halls and so on.



## Key Features

- 4K display, and the resolution of the input signal is up to 3840 × 2160.
- 20px ultra fine writing, and 1 mm writing in diameter recognizable.
- Built-in Wi-Fi realizes wireless screen mirroring without any cable connection.
- Built-in interactive whiteboard system allows annotating and sharing by scanning QR code.
- Display looping out.
- Various audio and video interfaces for device access.
- Built-in network switch chip saves a network switch.
- Built-in Android system supports kinds of applications.
- Compatible with OPS/OPS-C devices, and built-in systems can seamlessly switch between each other.
- Ultrathin aluminum profile frame design.



## Specifications

Model		DS-D5A75RB/A	
Screen	Diagonal Screen Size	75"	
	Backlight	LED Backlight	
	Resolution	3840 × 2160 @60 Hz	
	Display Scale	16:9	
	Pixel Pitch	0.429(H) × 0.429(V) mm	
	Color	10 bit	
	Brightness	350 cd/m <sup>2</sup>	
	Contrast	1200: 1	
	Response Time	8 ms	
	Viewing Angle	Horizontal 178°, vertical 178°	
Interface	HDMI In	2, Max. 4K@30Hz	
	HDMI Out	1, Max. 4K@60Hz	
	VGA In	1, Max. 1080P@60Hz	
	Audio In	2	
	Audio Out	2	
	USB Interface	2 USB on front panel , 2 USB on side panel	
	RJ45 (100Mbps ports)	2	
General	Power Supply	100 V to 240 VAC, 50/60 Hz	
	Power Consumption	< 500 W	
	Net Weight	57.620 kg	
	Gross Weight (with package)	74.620 kg	
	Product Dimensions (Width × Height × Thickness)	1737 × 1041 × 104 mm	
	Package Dimensions (Width × Height × Thickness )	1950 × 1225 × 293 mm	
	Working Temperature	0°C to 40°C	
	Working Humidity	10% to 90%	
	Built-in System	CPU	4-core Cortex-A53, 1.5 GHz
		Memory	2 GB



	<b>Storage</b>	32 GB
	<b>NIC</b>	Built-in 100Mbps NIC, supporting routing
	<b>Speaker</b>	Built-in 16 W speaker × 2
	<b>Decoding</b>	H.265/H.264, 4K@60 × 1
	<b>Operation System</b>	Android 5.0

## Available Models

DS-D5A75RB/A

## Physical Interface

Bottom interfaces of the rear panel:

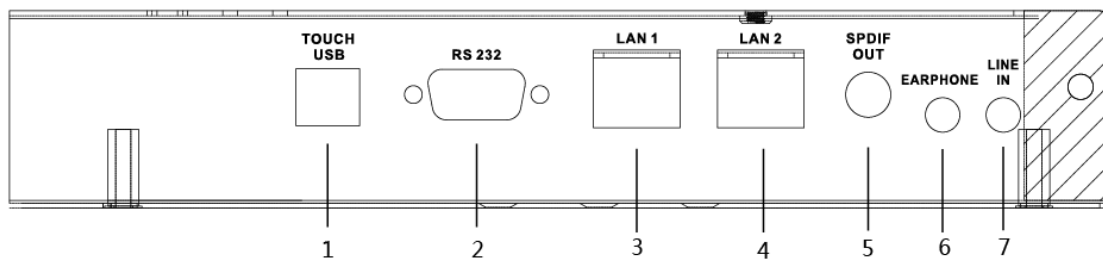

Interface	Description	Interface	Description
1.TOUCH-USB	Peripheral Touch Interface	2.RS-232	RS-232 Serial Port
3.LAN 1	Ethernet Interface 1	4. LAN 2	Ethernet Interface 2
5.SPDIF OUT	Digital Multi-media Speaker Interface	6.EARPHONE	Earphone Interface
7.LINE IN	Audio Input Interface	---	---

Left interfaces of the rear panel:

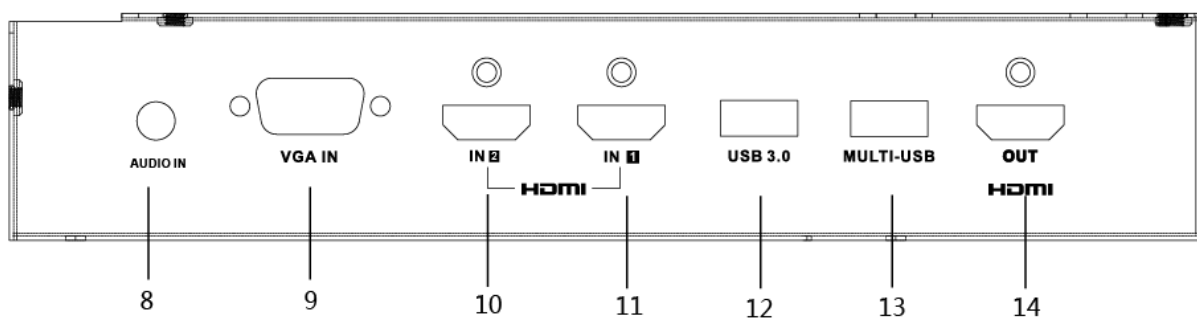

Interface	Description	Interface	Description
8.AUDIO IN	Audio Input Interface	9.VGA IN	VGA Input Interface
10.HDMI IN2	HDMI2 Input Interface	11.HDMI IN1	HDMI1 Input Interface
12.USB 3.0	USB 3.0 Interface	13.MULTI-USB	Multi-function USB Interface
14.HDMI OUT	HDMI Output Interface	---	---

**Dimensions (unit: mm)**

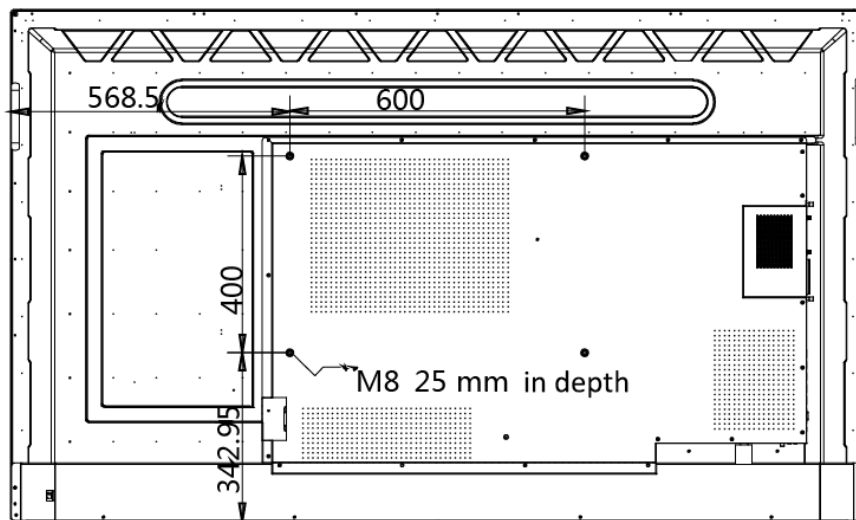
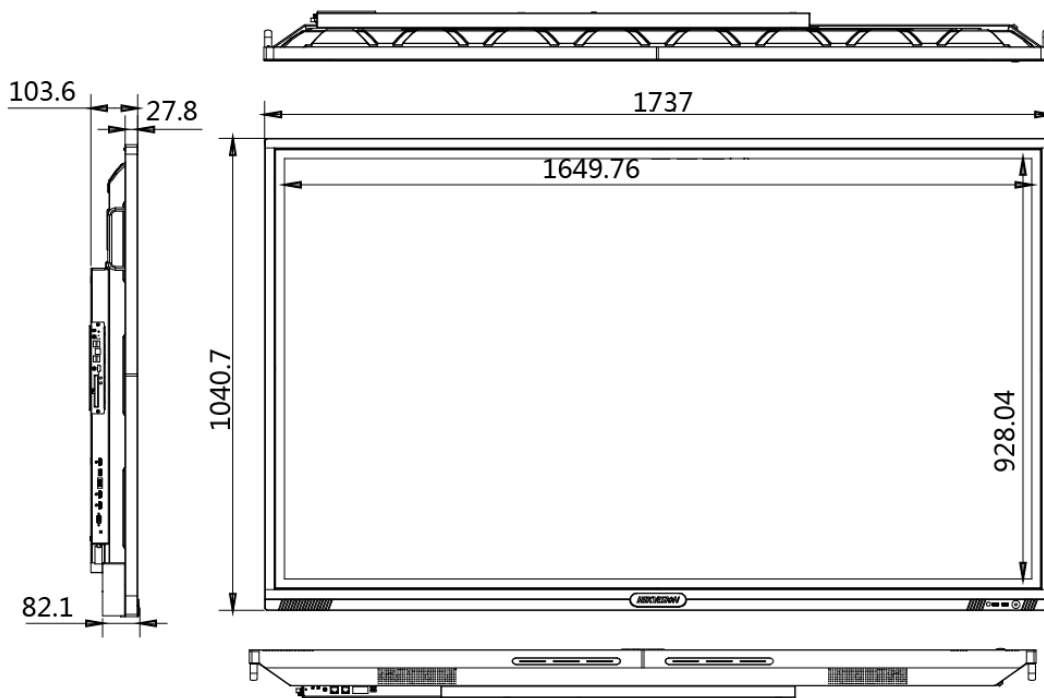

## Mounting Method

Wall mounting

The rear should be installed on the hook holes

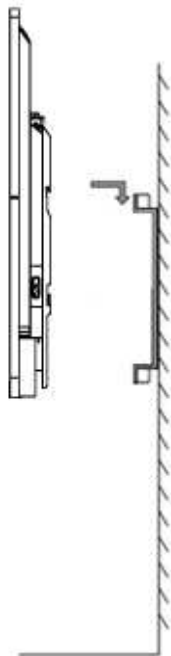
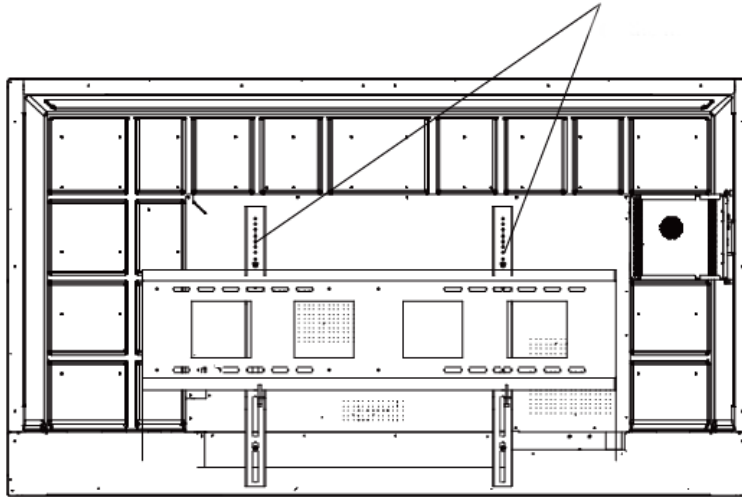

 **NOTE**

The bracket for wall mount can be moved horizontally. Please leave a space no less than 6 cm at each side, or a space no less than 12 cm at one side for maintenance service.

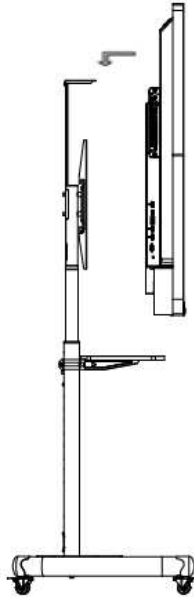
**Mobile Mounting**

Distributed by

**HIKVISION®****Headquarters**

No.555 Qianmo Road, Binjiang District,  
Hangzhou 310051, China  
T +86-571-8807-5998  
overseasbusiness@hikvision.com

**Hikvision USA**  
T +1-909-895-0400  
sales.usa@hikvision.com

**Hikvision Australia**  
T +61-2-8599-4233  
salesau@hikvision.com

**Hikvision India**  
T +91-22-28469900  
sales@pramahikvision.com

**Hikvision Canada**  
T +1-866-200-6690  
sales.canada@hikvision.com

**Hikvision Thailand**  
T +662-275-9949  
sales.thailand@hikvision.com

**Hikvision Europe**  
T +31-23-5542770  
sales.eu@hikvision.com

**Hikvision Italy**  
T +39-0438-6902  
info.it@hikvision.com

**Hikvision Brazil**  
T +55 11 3318-0050  
Latam.support@hikvision.com

**Hikvision Turkey**  
T +90 (216)521 7070- 7074  
sales.tr@hikvision.com

**Hikvision Malaysia**  
T +601-7652-2413  
sales.my@hikvision.com

**Hikvision UK & Ireland**  
T +01628-902140  
sales.uk@hikvision.com

**Hikvision South Africa**  
Tel: +27 (10) 0351172  
sale.africa@hikvision.com

**Hikvision France**  
T +33(0)1-85-330-450  
info.fr@hikvision.com

**Hikvision Kazakhstan**  
T +7-727-9730667  
nikia.panfilov@hikvision.ru

**Hikvision Vietnam**  
T +84-974270888  
sales.vt@hikvision.com

**Hikvision UAE**  
T +971-4-4432090  
salesme@hikvision.com

**Hikvision Singapore**  
T +65-6684-4718  
sg@hikvision.com

**Hikvision Spain**  
T +34-91-737-16-55  
info.es@hikvision.com

**Hikvision Tashkent**  
T +99-87-1238-9438  
uzb@hikvision.ru

**Hikvision Hong Kong**  
T +852-2151-1761  
info.hk@hikvision.com

**Hikvision Russia**  
T +7-495-669-67-99  
saleru@hikvision.com

**Hikvision Korea**  
T +82-(0)31-731-8817  
sales.korea@hikvision.com

**Hikvision Poland**  
T +48-22-460-01-50  
info.pl@hikvision.com

**Hikvision Indonesia**  
T +62-21-2933759  
Sales.Indonesia@hikvision.com

**Hikvision Colombia**  
sales.colombia@hikvision.com

DS-D5A65RB/A

## Interactive Tablet

The Interactive tablet (hereafter referred to as the “device”) integrates functions of computers, projectors, interactive whiteboards, sound boxes, cameras (optional), HDTVs, advertising machines and so on. The device integrates technologies like 4K display, infrared touch, human-machine interaction, multi-media information processing, and network transmission and provides users with various features such as writing, annotating, multi-screen sharing, and remote video call (optional).

The Interactive tablet is mainly used for remote video conferences, trainings and guidance, medical consulting, and other events in kinds of offices, meeting rooms, multi-media classrooms, exhibition halls and so on.



## Key Features

- 4K display, and the resolution of the input signal is up to 3840 × 2160.
- 20px ultra fine writing, and 1 mm writing in diameter recognizable.
- Built-in Wi-Fi realizes wireless screen mirroring without any cable connection.
- Built-in interactive whiteboard system allows annotating and sharing by scanning QR code.
- Display looping out.
- Various audio and video interfaces for device access.
- Built-in network switch chip saves a network switch.
- Built-in Android system supports kinds of applications.
- Compatible with OPS/OPS-C devices, and built-in systems can seamlessly switch between each other.
- Ultrathin aluminum profile frame design.



## Specifications

Model		DS-D5A65RB/A
Screen	Diagonal Screen Size	65"
	Backlight	LED Backlight
	Resolution	3840 × 2160 @60 Hz
	Display Scale	16:9
	Pixel Pitch	0.496(H) × 0.372(V) mm
	Color	10 bit
	Brightness	400 cd/m <sup>2</sup>
	Contrast	1200: 1
	Response Time	6 ms
	Viewing Angle	Horizontal 178°, vertical 178°
Interface	HDMI In	2, Max. 4K@30Hz
	HDMI Out	1, Max. 4K@60Hz
	VGA In	1, Max. 1080P@60Hz
	Audio In	2
	Audio Out	2
	USB Interface	2 USB on front panel , 2 USB on side panel
	RJ45 (100Mbps ports)	2
General	Power Supply	100 to 240 VAC, 50/60 Hz
	Power Consumption	< 300 W
	Net Weight	50.500 kg
	Gross Weight (with package)	62.500 kg
	Product Dimensions (Width × Height × Thickness)	1505 × 907 × 114 mm
	Package Dimensions (Width × Height × Thickness )	1735 × 1105 × 290 mm
	Working Temperature	0°C to 40°C
	Working Humidity	10% to 90%
	Built-in System	CPU
Memory		2 GB

	<b>Storage</b>	32 GB
	<b>NIC</b>	Built-in 100Mbps NIC, supporting routing
	<b>Speaker</b>	Built-in 16 W speaker × 2
	<b>Decoding</b>	H.265/H.264, 4K@60 × 1
	<b>Operation System</b>	Android 5.0

## Available Models

DS-D5A65RB/A

## Physical Interface

Bottom interfaces of the rear panel:

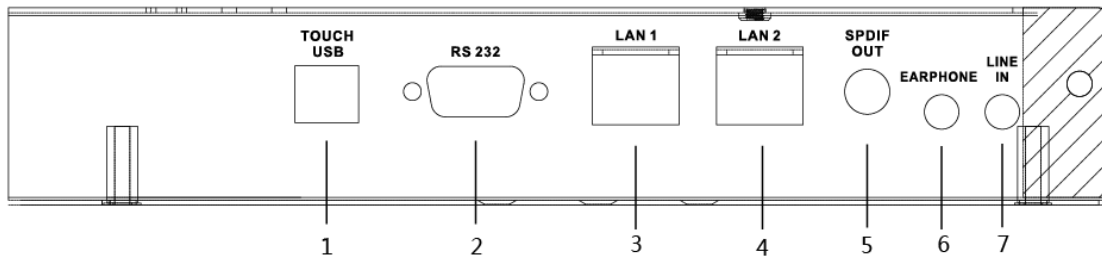

Interface	Description	Interface	Description
1.TOUCH-USB	Peripheral Touch Interface	2.RS-232	Serial Port
3.LAN 1	Ethernet Interface 1	4. LAN 2	Ethernet Interface 2
5.SPDIF OUT	Digital Multi-media Speaker Interface	6.EARPHONE	Earphone Interface
7.LINE IN	Audio Input Interface	---	---

Left interfaces of the rear panel:

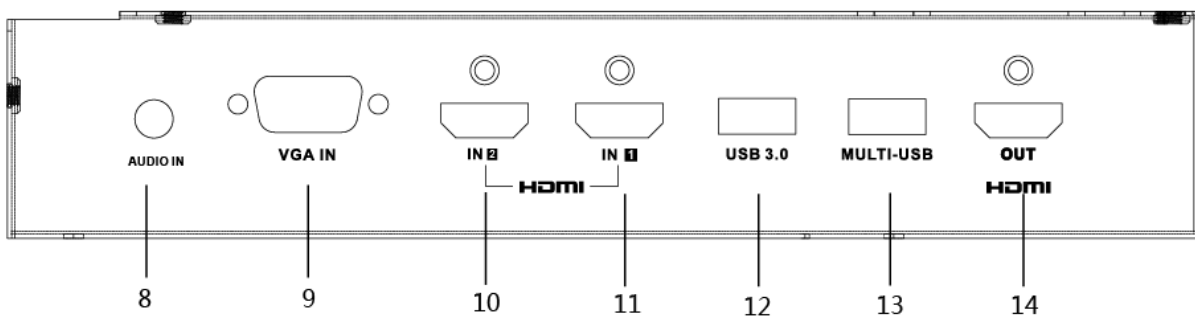

Interface	Description	Interface	Description
8.AUDIO IN	Audio Input Interface	9.VGA IN	VGA Input Interface
10.HDMI IN2	HDMI2 Input Interface	11.HDMI IN1	HDMI1 Input Interface
12.USB 3.0	USB 3.0 Interface	13.MULTI-USB	Multi-function USB Interface
14.HDMI OUT	HDMI Output Interface	---	---

**Dimensions (unit: mm)**

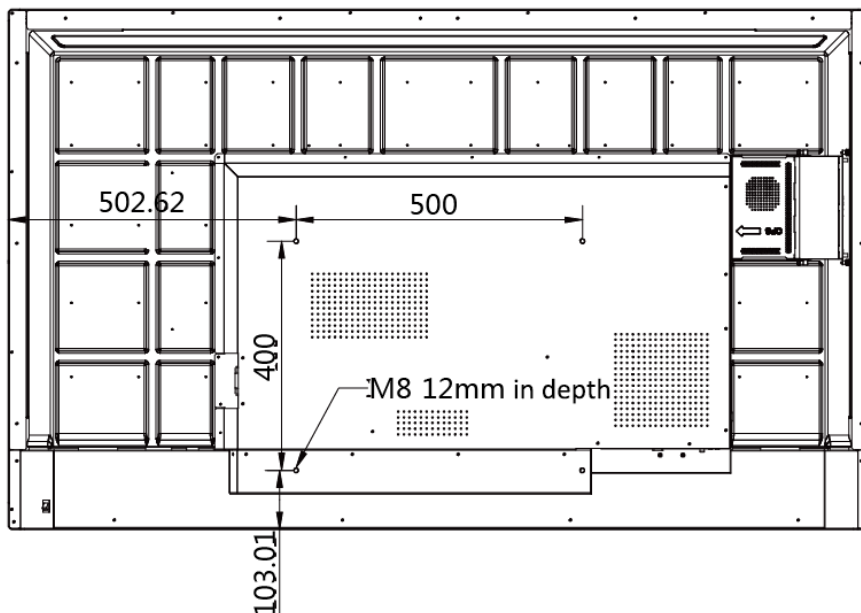
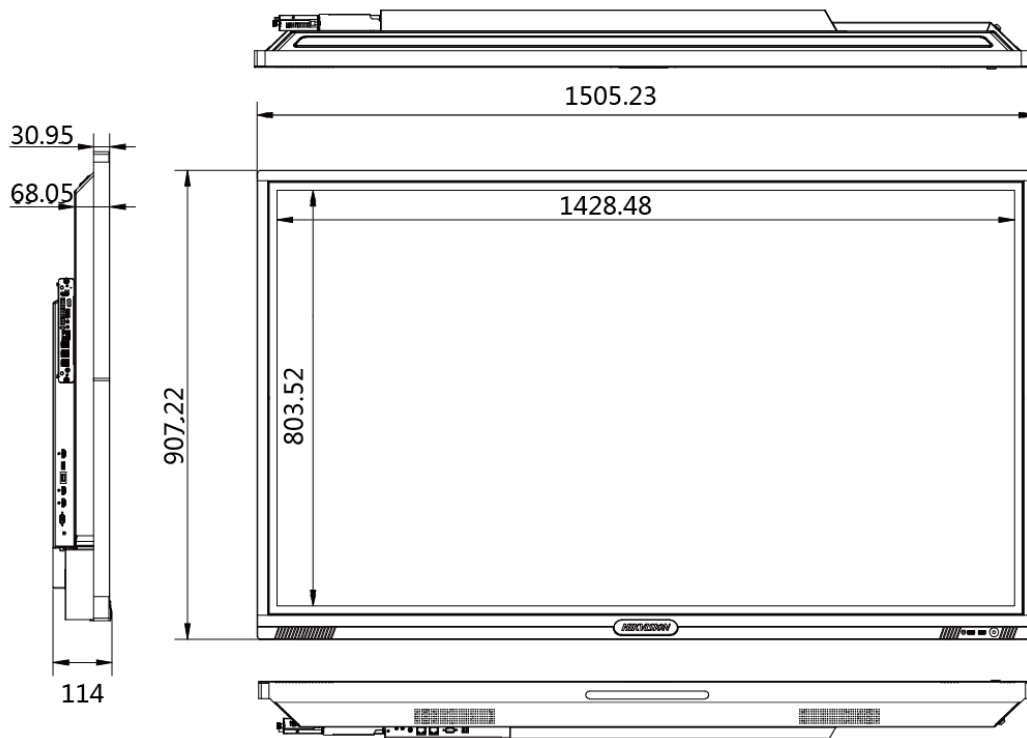



## Mounting Method

Wall mounting

The rear should be installed on the hook holes

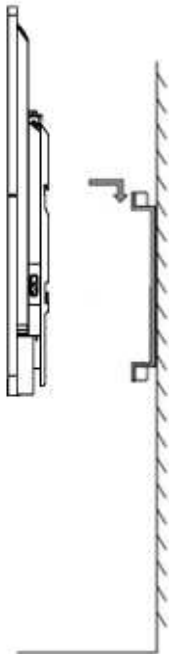
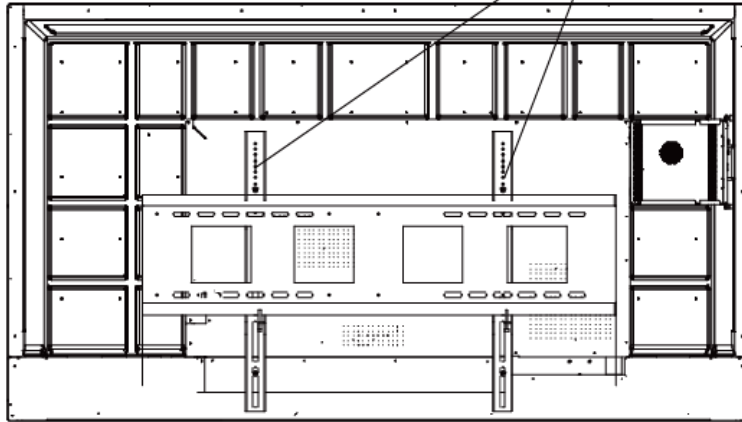

 **NOTE**

The bracket for wall mount can be moved horizontally. Please leave a space no less than 6 cm at each side, or a space no less than 12 cm at one side for maintenance service.

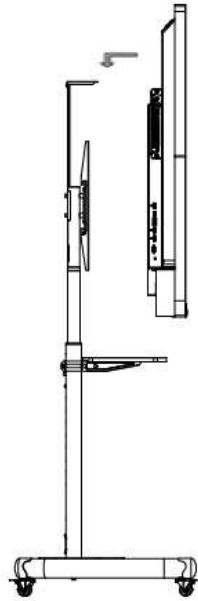
**Mobile Mounting**

Distributed by

**HIKVISION®****Headquarters**

No.555 Qianmo Road, Binjiang District,  
Hangzhou 310051, China  
T +86-571-8807-5998  
overseasbusiness@hikvision.com

**Hikvision USA**  
T +1-909-895-0400  
sales.usa@hikvision.com

**Hikvision Australia**  
T +61-2-8599-4233  
salesau@hikvision.com

**Hikvision India**  
T +91-22-28469900  
sales@pramahikvision.com

**Hikvision Canada**  
T +1-866-200-6690  
sales.canada@hikvision.com

**Hikvision Thailand**  
T +662-275-9949  
sales.thailand@hikvision.com

**Hikvision Europe**  
T +31-23-5542770  
sales.eu@hikvision.com

**Hikvision Italy**  
T +39-0438-6902  
info.it@hikvision.com

**Hikvision Brazil**  
T +55 11 3318-0050  
Latam.support@hikvision.com

**Hikvision Turkey**  
T +90 (216)521 7070- 7074  
sales.tr@hikvision.com

**Hikvision Malaysia**  
T +601-7652-2413  
sales.my@hikvision.com

**Hikvision UK & Ireland**  
T +01628-902140  
sales.uk@hikvision.com

**Hikvision South Africa**  
Tel: +27 (10) 0351172  
sale.africa@hikvision.com

**Hikvision France**  
T +33(0)1-85-330-450  
info.fr@hikvision.com

**Hikvision Kazakhstan**  
T +7-727-9730667  
nikia.panfilov@hikvision.ru

**Hikvision Vietnam**  
T +84-974270888  
sales.vt@hikvision.com

**Hikvision UAE**  
T +971-4-4432090  
salesme@hikvision.com

**Hikvision Singapore**  
T +65-6684-4718  
sg@hikvision.com

**Hikvision Spain**  
T +34-91-737-16-55  
info.es@hikvision.com

**Hikvision Tashkent**  
T +99-87-1238-9438  
uzb@hikvision.ru

**Hikvision Hong Kong**  
T +852-2151-1761  
info.hk@hikvision.com

**Hikvision Russia**  
T +7-495-669-67-99  
saleru@hikvision.com

**Hikvision Korea**  
T +82-(0)31-731-8817  
sales.korea@hikvision.com

**Hikvision Poland**  
T +48-22-460-01-50  
info.pl@hikvision.com

**Hikvision Indonesia**  
T +62-21-2933759  
Sales.Indonesia@hikvision.com

**Hikvision Colombia**  
sales.colombia@hikvision.com

## DS-D5A55RB/B Interactive Tablet

The Interactive tablet (hereafter referred to as the “device”) integrates functions of computers, projectors, interactive whiteboards, sound boxes, cameras (optional), HDTVs, advertising machines and so on. The device integrates technologies like 4K display, infrared touch, human-machine interaction, multi-media information processing, and network transmission and provides users with various features such as writing, annotating, multi-screen sharing, and remote video call (optional).

The Interactive tablet is mainly used for remote video conferences, trainings and guidance, medical consulting, and other events in kinds of offices, meeting rooms, multi-media classrooms, exhibition halls and so on.



### Key Features

- 4K display, and the resolution of the input signal is up to 3840 × 2160.
- 10 px ultra fine writing, and 2 mm writing in diameter recognizable.
- Built-in interactive whiteboard system allows sharing by scanning QR code.
- Annotating on any interfaces supports 10 people writing at the same time.
- Built-in Wi-Fi realizes wireless screen mirroring supporting 2/4-split screen without any cable connection.
- Software and hardware video conferences realize tele-cooperation.







## ▪ Specification

Model		DS-D5A55RB/B
<b>Product Model</b>	Product Model	DS-D5A55RB/B
<b>Display</b>	Viewing Angle	178°(H)/178°(V)
	Screen Size	55 inch LED Backlight
	Backlight	DLED
	Pixel Pitch	0.315(H) mm × 0.315(V) mm
	Resolution	3840 × 2160 @60 Hz
	Brightness	350 cd/m <sup>2</sup>
	Color Depth	10 bit
	Contrast Ratio	1200:1 (Typ.)
	Response Time	9 ms
	Color Gamut	68% NTSC
	Reliability	7 x 18H
	Refresh Rate	60 Hz
	Haze	3%
	<b>Touch</b>	Type
Touch Point		10 point multi-touch
Touch Response Time		< 15 ms
Touch Precision		±2 mm (≥ 90% touching area)
<b>Built-in System</b>	Operation System	Android 8.0
	Processor	4-core A73 × 2 + A53 × 2, 1.5 GHz
	Memory	3 GB
	Built-in Storage	32 GB
	Net Card	Built-in 100Mbps NIC, supporting routing
<b>Interface</b>	Video & Audio Input	HDMI IN × 2, VGA IN × 1, PC AUDIO IN × 1, LINE IN × 1
	Video & Audio Output	HDMI OUT × 1, LINE OUT × 1, SPDIF OUT × 1, Built-in 16 W speaker × 2
	Network Interface	RJ45 (100Mbps ports) × 2
	Data Transmission Interface	2 USB on front panel , 2 USB on rear panel
	Control Interface	RS-232 × 1
<b>Power</b>	Standby Power	0.5 W
	Consumption	< 180 W (full load)
<b>Working Environment</b>	Operation Temperature	0°C~40°C
	Operation Humidity	10%~90% RH
	Storage Temperature	10%~60% RH
	Storage Humidity	-10°C~ 60 °C
<b>General</b>	Power Supply	100 V to 240 VAC, 50/60 Hz
	Gross Weight	42 Kg (92.59 lb)
	Net Weight	33.1 Kg (72.97 lb)
	Package Dimensions (W × H × T)	1420 mm × 910 mm × 245 mm (55.90" × 35.83" × 9.65")
	Product Dimensions (W × H × T)	1299.9 mm × 810.8 mm × 96.7 mm (51.18" × 31.92" × 3.81")

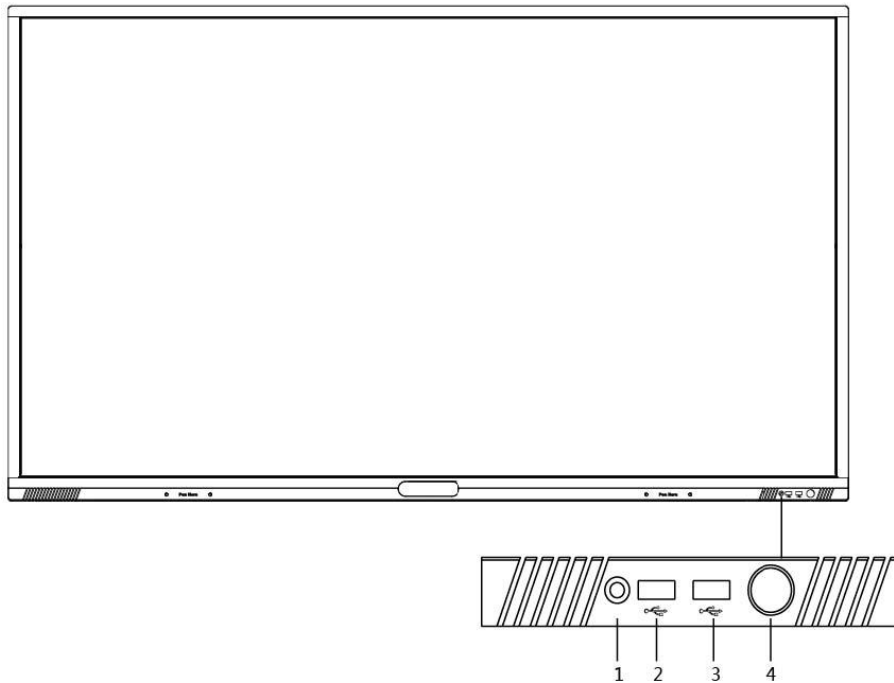
▪ **Physical Interface**

Front panel:



Interface	Description
1. 	Light sensor
2-3. USB	Self- adaptive PC-USB and Android-USB
4. 	Power button Short press to go to power saving status. Long press to turn on or turn off the device.
5. 	Power interface
6. 	Power switch

Bottom interfaces of the rear panel:

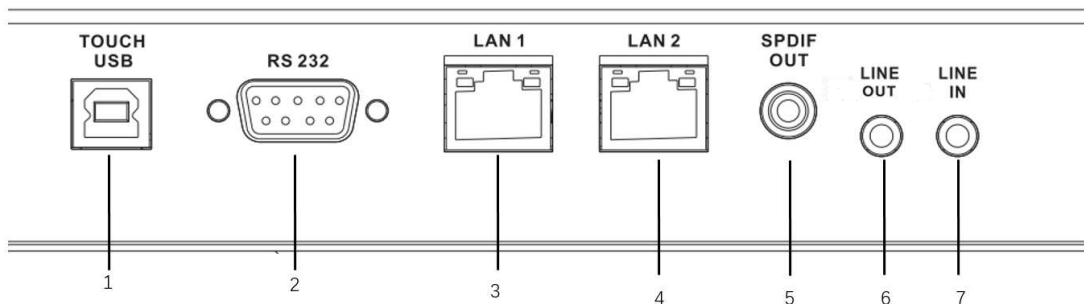

Left interfaces of the rear panel:

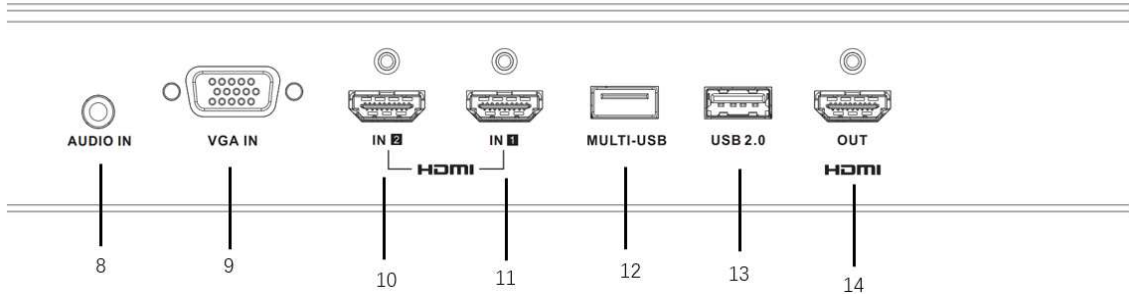

Interface	Description	Interface	Description
1.TOUCH-USB	Peripheral Touch Interface	2.RS-232	RS-232 Serial Port
3.LAN 1	Ethernet Interface 1	4.LAN 2	Ethernet Interface 2
5.SPdif OUT	Digital Multi-media Speaker Interface	6.LINE OUT	Earphone Interface
7.LINE IN	Audio Input Interface	---	---
8.AUDIO IN	Audio Input Interface	9.VGA IN	VGA Input Interface
10.HDMI IN2	HDMI2 Input Interface	11.HDMI IN1	HDMI1 Input Interface
12.MULTI-USB	Multi-function USB Interface	13.USB 2.0	USB 2.0 Interface
14.HDMI OUT	HDMI Output Interface	---	---

▪Dimensions (unit: mm)

Without wall-mounted backboard:

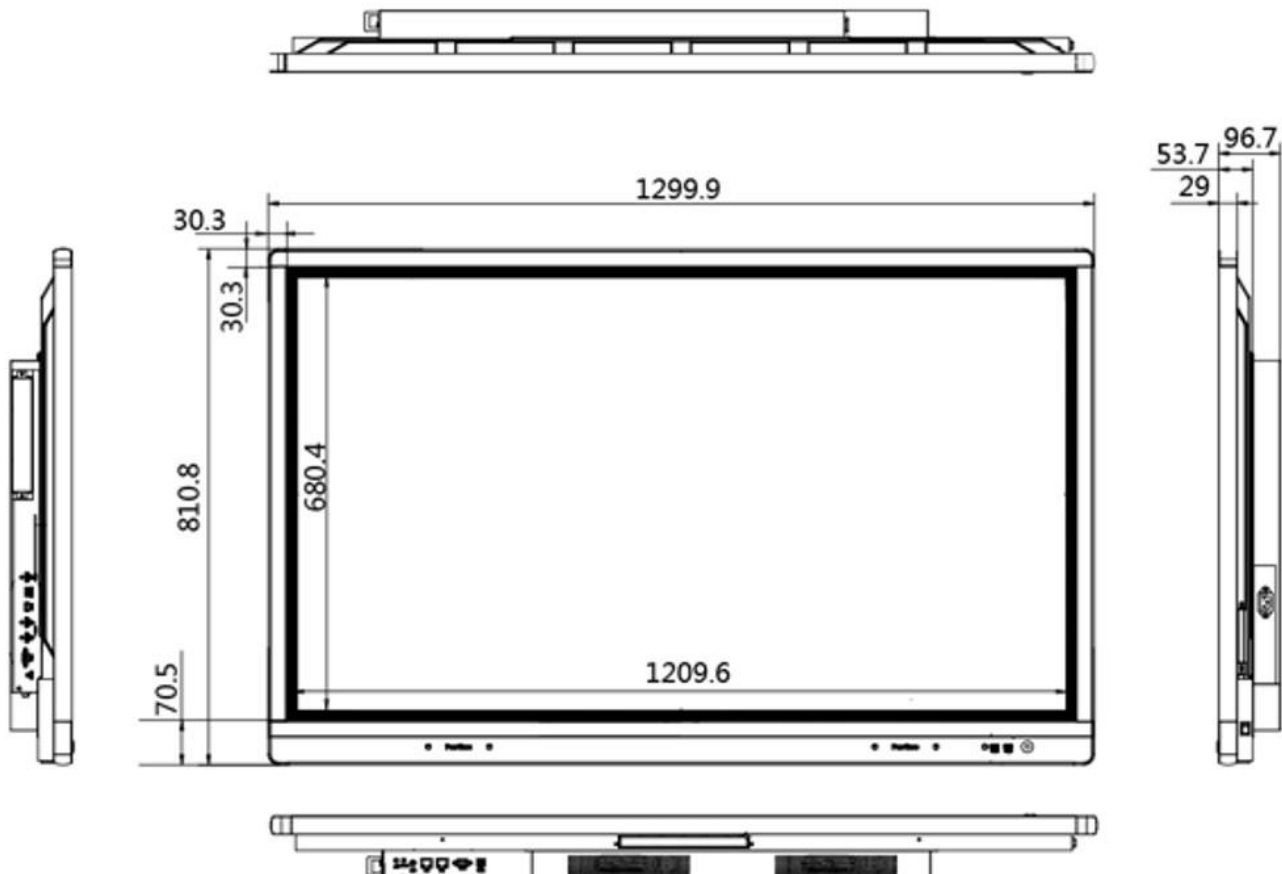

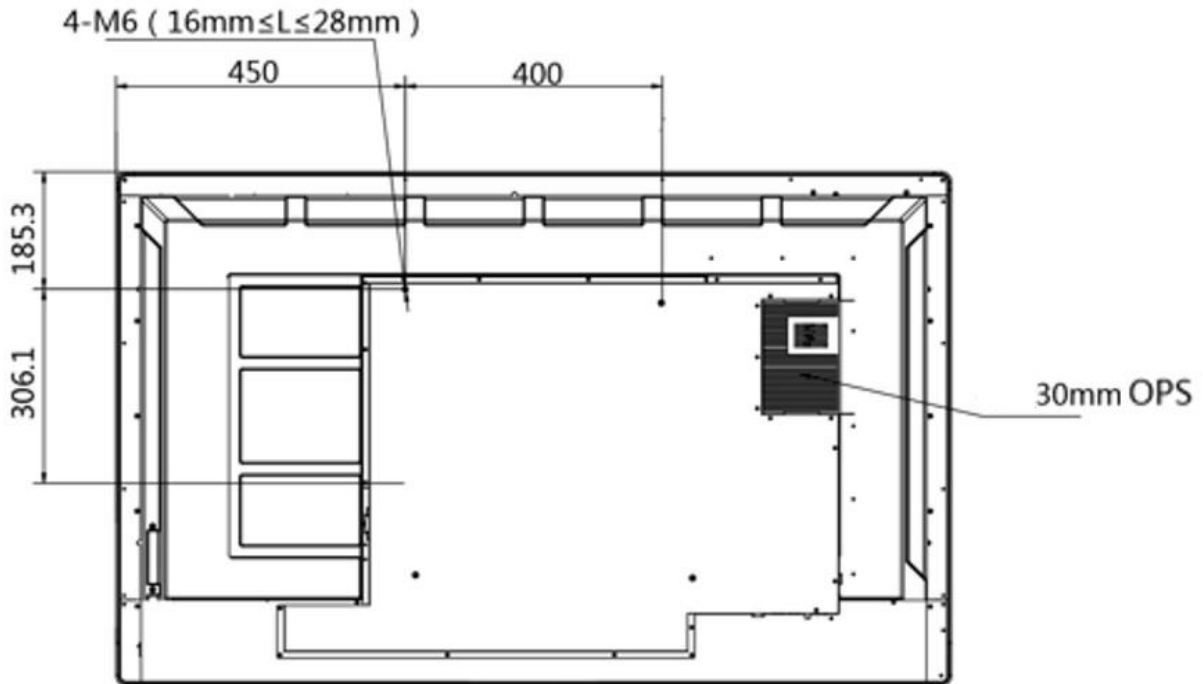

▪ **Installation**

Wall mounting

The rear should be installed on the hook holes

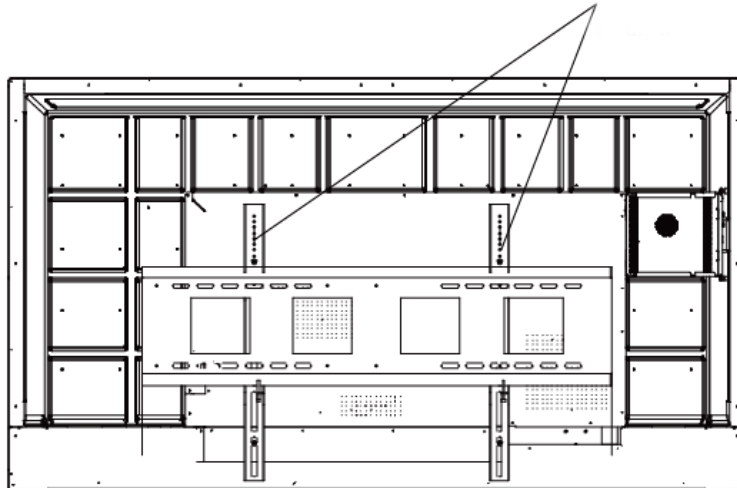

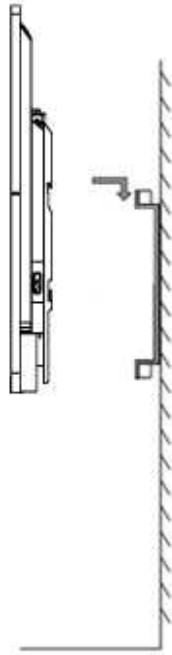
**i NOTE**

The bracket for wall mount can be moved horizontally. Please leave a space no less than 6 cm at each side, or a space no less than 12 cm at one side for maintenance service.

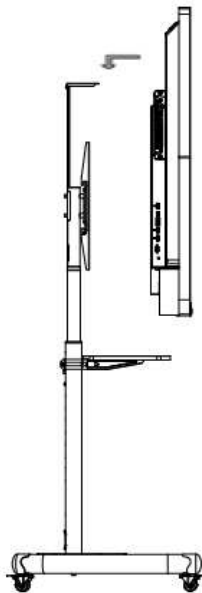
**Mobile Mounting****▪ Accessory**

- DS-D5AS5/8S1L
- DS-D5AS7/8S2L

**▪ Available Model**

- DS-D5A55RB/B





Distributed by

**HIKVISION®****Headquarters**

No.555 Qianmo Road, Binjiang District,  
Hangzhou 310051, China  
T +86-571-8807-5998  
overseasbusiness@hikvision.com

**Hikvision USA**

T +1-909-895-0400  
sales.usa@hikvision.com

**Hikvision Australia**

T +61-2-8599-4233  
salesau@hikvision.com

**Hikvision India**

T +91-22-28469900  
sales@pramahikvision.com

**Hikvision Canada**

T +1-866-200-6690  
sales.canada@hikvision.com

**Hikvision Thailand**

T +662-275-9949  
sales.thailand@hikvision.com

**Hikvision Europe**

T +31-23-5542770  
sales.eu@hikvision.com

**Hikvision Italy**

T +39-0438-6902  
info.it@hikvision.com

**Hikvision Brazil**

T +55 11 3318-0050  
Latam.support@hikvision.com

**Hikvision Turkey**

T +90 (216)521 7070- 7074  
sales.tr@hikvision.com

**Hikvision Malaysia**

T +601-7652-2413  
sales.my@hikvision.com

**Hikvision UK & Ireland**

T +01628-902140  
sales.uk@hikvision.com

**Hikvision South Africa**

Tel: +27 (10) 0351172  
sale.africa@hikvision.com

**Hikvision France**

T +33(0)1-85-330-450  
info.fr@hikvision.com

**Hikvision Kazakhstan**

T +7-727-9730667  
nikia.panfilov@hikvision.ru

**Hikvision Vietnam**

T +84-974270888  
sales.vt@hikvision.com

**Hikvision UAE**

T +971-4-4432090  
salesme@hikvision.com

**Hikvision Singapore**

T +65-6684-4718  
sg@hikvision.com

**Hikvision Spain**

T +34-91-737-16-55  
info.es@hikvision.com

**Hikvision Tashkent**

T +99-87-1238-9438  
uzb@hikvision.ru

**Hikvision Hong Kong**

T +852-2151-1761  
info.hk@hikvision.com

**Hikvision Russia**

T +7-495-669-67-99  
saleru@hikvision.com

**Hikvision Korea**

T +82-(0)31-731-8817  
sales.korea@hikvision.com

**Hikvision Poland**

T +48-22-460-01-50  
info.pl@hikvision.com

**Hikvision Indonesia**

T +62-21-2933759  
Sales.Indonesia@hikvision.com

**Hikvision Colombia**

sales.colombia@hikvision.com